

Type DDSU666.004.0006 Single phase electronic energy meter

(DIN-Rail)

Operation Manual

ZTY0.464.1224

Zhejiang Chint Instrument & Meter Co., Ltd.

May, 2019

DDSU666.004 .0006type single phase electronic energy meter(DIN-Rail)	ZTY0.464.1224
Operation manual	Page 1, Total 21

1. Brief Introduction

1.1 Main application & applicable range

Type DDSU666 single phase electronic energy meter (din-rail) (hereinafter referred to as the “instrument”) is designed based on power monitoring and energy metering demands for electric power system, communication industry, construction industry, etc. as a new generation of intelligent instrument combining measurement and communication function, mainly applied into the measurement and display for the electric parameters in the electric circuit including voltage, current, power, frequency, power factor, active energy, etc. The network can be realized through RS485 communication interface and external device. Adopting the standard DIN35mm din rail mounting and modular design, it is characterized with small volume, easy installation and easy networking, widely applied into the internal energy monitoring and assessment for industrial and mining enterprises, hotels, schools, large public buildings.

Complied standards:

IEC62052-11 《Electricity metering equipment(AC)-General requirements, tests and test conditions- Part11: Metering equipment 》;

IEC62053-21 《Electricity metering equipment(AC)-Particular requirements-Part21: Static meters for active energy(classes 1 and 2)》;

MODBUS-RTU protocol.

1.2 Product Features

- 1) Metering the positive and negative active power;
- 2) Adopting wide LCD, it has clear vision.
- 3) RS485 communication function with communication protocol complied with Modbus-RTU;
- 4) Adopting DIN35mm standard din rail mounting, structural modular design, it is characterized with small volume, easy installation and easy networking.

DDSU666.004.0006 type single phase electronic energy meter(DIN-Rail)	ZTY0.464.1036
Operation manual	Page 2, Total 21

1.3 Model composition and meanings

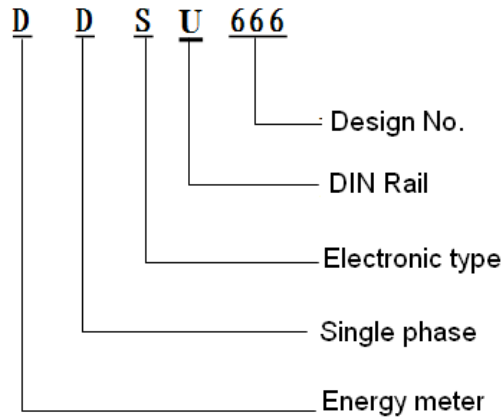

Figure 1 Model No. & meanings

1.4 Applicable environmental condition.

Regulated working temperature range: $-25^{\circ}\text{C} \sim +60^{\circ}\text{C}$;

Limited working temperature range: $-35^{\circ}\text{C} \sim +70^{\circ}\text{C}$;

Relative humidity(Annually average):75% ;

Atmospheric pressure:86kPa \sim 106kPa.

2. Working Principle

The working principle block diagram of the instrument is shown in figure 2:

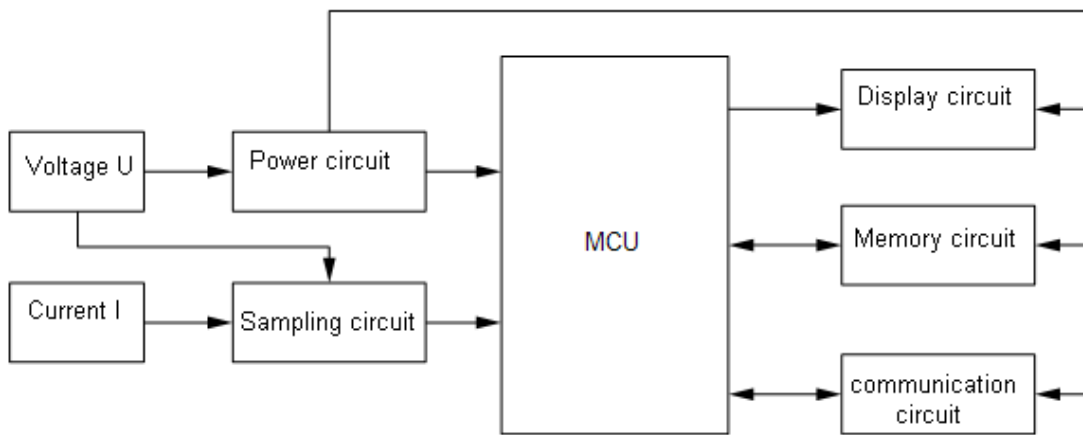

Figure 2 Work principle block diagram

DDSU666.004.0006 type single phase electronic energy meter(DIN-Rail)	ZTY0.464.1036
Operation manual	Page 3, Total 21

3. Main Technical Performance & Parameters

3.1 Model specification

Table 1 Model specification

Model	Accuracy class	Frequency	Reference voltage	Current specification	Instrument constant	Type
DDSU666.004.0004	Active Class 1	60Hz	230 V	5(80)A	800imp/kWh	Direct connection
DDSU666.004.0004	Active Class1	60Hz	230 V	1.5(6)A	6400imp/kWh	Via transformer

Note: Please take the physical sign as standard.

3.2 Percentage error

Table 2 Percentage error of single phase energy meter not exceeding the below corresponding limited value

Type	Current range	Power factor	Percentage error limit of each class instrument (%)
			Class 1
Via CT	$0.01I_n \leq I < 0.05I_n$	1	±1.5
	$0.05I_n \leq I \leq I_{max}$	1	±1.0
	$0.02I_n \leq I < 0.1I_n$	0.5L、0.8C	±1.5
	$0.1I_n \leq I \leq I_{max}$	0.5L、0.8C	±1.0
Direct connection	$0.05I_b \leq I < 0.1I_b$	1	±1.5
	$0.1I_b \leq I \leq I_{max}$	1	±1.0
	$0.01I_b \leq I < 0.2I_b$	0.5L、0.8C	±1.5
	$0.2I_b \leq I \leq I_{max}$	0.5L、0.8C	±1.0
remark	I_n : secondary rated current of CT; I_b : calibrated current of the energy meters; L: inductive; C: capacitive		

3.3 Start

Table 3 Under the referenced voltage and table 4, the energy meter can be started and continuously measure the energy

DDSU666.004.0006 type single phase electronic energy meter(DIN-Rail)	ZTY0.464.1036
Operation manual	Page 4, Total 21

Instrument	Accuracy class of the energy meter	Power factor
	Class 1	
Direct connection	$0.004I_b$	1
Via transformer	$0.002I_n$	

3.4 Deflection

The electric energy meter should have good anti-deflection logic. When the voltage loop with 1.15 times of referenced voltage and the current loop is disconnected, the energy will not produce more than one pulse.

3.5 Electrical parameters

Table 4 Electrical parameters

Specified operating voltage range	$0.9U_n \sim 1.1U_n$
Extended operating voltage range	$0.8U_n \sim 1.15U_n$
Ultimate operating voltage range	$0 U_n \sim 1.15U_n$
Power consumption of the voltage circuit	$\leq 1W/8VA$
Power consumption of the current circuit	$\leq 2.5VA$

3.6 Other technical parameters

Table 5 Other technical parameters

Measuring range	$0 \sim 999999.99$ kWh (only display 6 bit,, automatic shift of decimal point)
Display mode	LCD display
Communication protocol	Modbus-RTU protocol

3.7 Adoption for key components

Table 6 Adoption for key components

Metering chip	SH79F7019
Crystal	32.768kHz
Power transformer	ZTY6.170.234
Printed wiring board	1.5 (6) A:ZTY8.067.2729V2、ZTY8.067.2731V2、ZTY8.067.2732V2

DDSU666.004.0006 type single phase electronic energy meter(DIN-Rail)	ZTY0.464.1036
Operation manual	Page 5, Total 21

	5 (80) A : ZTY8.067.2729V2、ZTY8.067.2730V2 (Note: the actual plate number is determined according to the actual sample table)
Current transformer	ZTY6.176.301

4. Main functions

4.1 Metering function

- 1) Accurately metering the positive and negative active power;
- 2) The storage data of the electric energy meter will not lost after powering off.

4.2 Displayed functions

When the energy meter is in normal working condition (on load state), the positive pulse indicator should be flashed. If long time for no flashing or light for the indicator, please check whether the wiring mode of the energy meter is right or not.

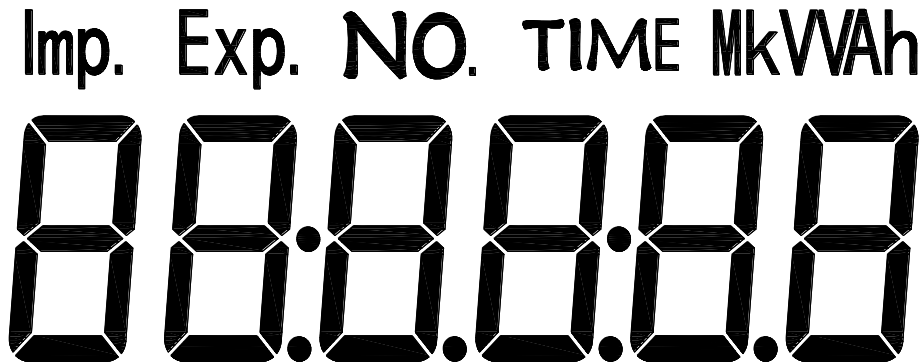

Table 7 LCD logo meanings

Symbol	Meaning
V	The unit of the voltage, the display data of indicating LCD is voltage
A	The unit of the current, the display data of indicating LCD is current
W	The unit of the active power, the display data of indicating LCD is active power
var	The unit of the reactive power, the display data of indicating LCD is reactive power





DDSU666.004.0006 type single phase electronic energy meter(DIN-Rail)	ZTY0.464.1036
Operation manual	Page 6, Total 21



Hz	The unit of the frequency, the display data of indicating LCD is frequency
kWh	The unit of the active energy, the display data of indicating LCD is active energy

The display time of the measurement data is five seconds and information sample for every page of the measured information of measurement data (if not consistent with the instrument panel, please take the object as standard.)

Light time of the background: 1 min.

Table 8 Display Instruction

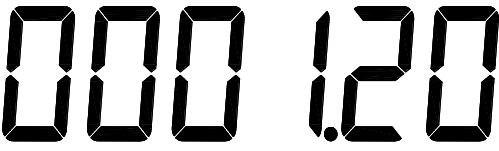
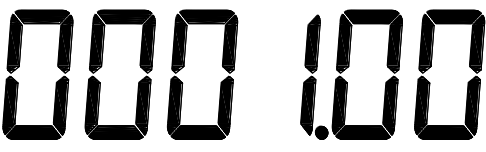
Content	Instruction
	Means the current display voltage is U, the unit is “V”, the left picture is U=220.0V。
	Means the current display current is I, the unit is “A”, the left picture is I=5.000A.
	Means the current display is the active power P, the unit is “kW”, the left picture is P=1.100kW.
	Means the current display is the power factor Ft, the left picture is Ft=1.000.
	Means the current display is frequency F, the left picture is F=50.00Hz.

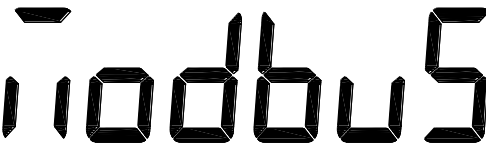
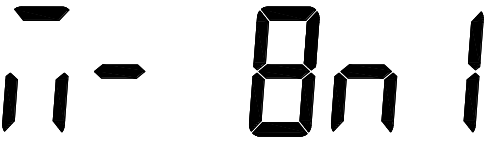
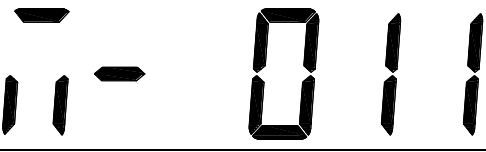
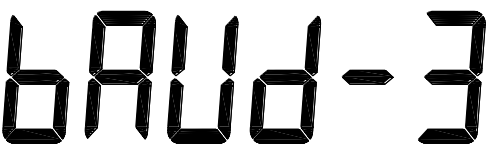
<p>Imp. kW h</p> 	<p>Means the current positive active energy EImp, the unit is “kWh”, the left picture is EImp=1.20kWh.</p>
<p>Exp. kW h</p> 	<p>Means the current negative active energy EExp, the unit is “kWh”, the left picture is EExp=1.00kWh.</p>
<p>kW h</p> 	<p>Means the current combination active energy total ComEp, the unit is “kWh”, the left picture is ComEp=2.20kWh.</p>
<p>NO.</p> 	<p>Means the current communication protocol is Modbus.</p>
<p>NO.</p> 	<p>Represents 8 data bits, no effect bit and one stop bit of the current communication protocol.</p>
<p>NO.</p> 	<p>Means the current communication address is 11.</p>
<p>NO.</p> 	<p>Means the current communication baud rate is 9600.</p>

DDSU666.004.0006 type single phase electronic energy meter(DIN-Rail)	ZTY0.464.1036
Operation manual	Page 8, Total 21

Keyboard operation: After pressing the button for a long time, the display interface enters the switching interface of setting 645 protocol and Modbus protocol. Shortly press can switch the protocol, not the address page (only the ModBus protocol can be switched to the address page), the address of ModBus can be set by the button, the button can set the address range 1-99.

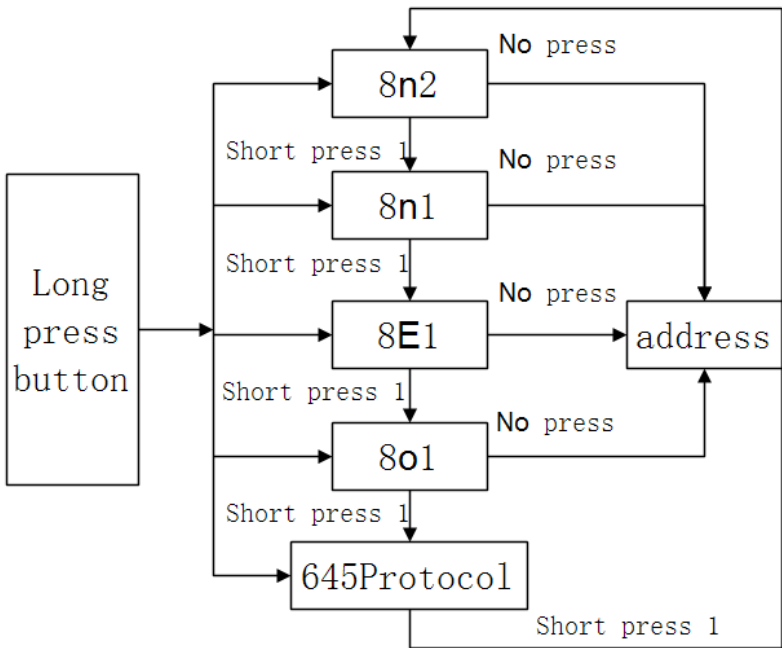

Figure 3 Long press button

4.3 Communication function

The instrument adopts RS485 communication mode with baud rate to be set as 1200, 2400bps, 4800bps and 9600bps.

For a same communication circuit, it can at most be connected with thirty-two instruments at the same time, with each instrument to be set as their communication address. For the communication connection, it should use shielded twisted pair with copper mesh with wire diameter not below 0.5mm² . On wiring arrangement, the communication line shall be away from strong cable or other strong electric field with the maximum transmission distance to be 1200m. For the typical networking connection mode, please see the below figure, users can select other suitable connection mode based on detailed conditions.

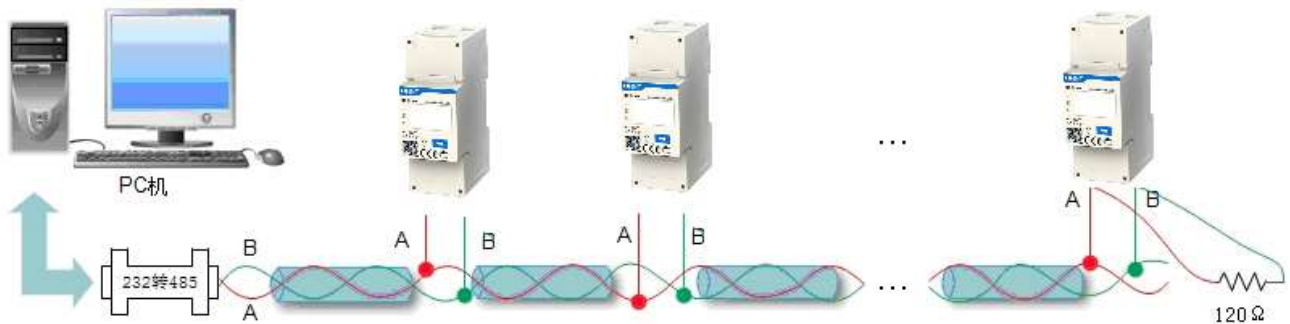

Figure 4 Schematic diagram of communication connection

When the instrument is set to be ModBus-RTU transmission mode, ModBus-RTU communication protocol adopts host-slave response in one communication line. Firstly, the host computer's signal will seek for a terminal device (slave) with only one address, then the terminal device will produce response signal and transmit to the host computer in opposite direction, that is, half duplex working mode. This protocol only allows communication between the host (PC, PLC, etc.) and the terminal device, rather than data exchanges between the independent terminal devices. Thus, each terminal device will not occupy the communication circuits in their initialization, and only be limited to response the query signal to the host computer.

The instrument can provide ModBus-RTU communication protocol (see appendix A), for the parameter information to be read or modified by the communication, please see the below table.

Table 9 Communication parameter information

Parameter address	Parameter code	Instruction of the parameters	Type of data	Length of data Word	Read&write attributes
0000H	UCode	Programming password codeE	16-bit with symbols	1	R/W
0001H	REV.	Reserved, actual read is the version number	16-bit with symbols	1	R
0002H	ClrE	Electric energy zero clearing CLr.E(1:zero clearing)	16-bit with symbols	1	R/W

DDSU666.004.0006 type single phase electronic energy meter(DIN-Rail)	ZTY0.464.1036
Operation manual	Page 10, Total 21

0003H	RESERVED	RESERVED	16-bit with symbols	1	
0004H	RESERVED	RESERVED	16-bit with symbols	1	
0005H	ChangeProtocol	Protocol changing-over	16-bit with symbols	1	R/W
0006H	Addr	Communication address Addr	16-bit with symbols	1	R/W
0007H	Urat	RESERVED	16-bit with symbols	1	
0008H	Irat	RESERVED	16-bit with symbols	1	
0009H	RESERVED	RESERVED	16-bit with symbols	1	
000AH	RESERVED	RESERVED	16-bit with symbols	1	
000BH	RESERVED	RESERVED	16-bit with symbols	1	
000CH	BAud	Communication baud rate bAud	16-bit with symbols	1	R/W
000DH	RESERVED	RESERVED	16-bit with symbols	1	
000EH	RESERVED	RESERVED	16-bit with symbols	1	
000FH	RESERVED	RESERVED	16-bit with symbols	1	
0010H	RESERVED	RESERVED	16-bit with symbols	1	

DDSU666.004.0006 type single phase electronic energy meter(DIN-Rail)	ZTY0.464.1036
Operation manual	Page 11, Total 21

Electric quantity of the secondary side					
2000H	U	Voltage	single precision floating decimal	2	R
2002H	I	Current	single precision floating decimal	2	R
2004H	P	Conjunction active power, the unit is KW	single precision floating decimal	2	R
2006H	Q	Conjunction reactive power, the unit is Kvar	single precision floating decimal	2	R
2008H	RESERVED	RESERVED	single precision floating decimal	2	R
200AH	PF	Conjunction power factor	single precision floating decimal	2	R
200CH	RESERVED	RESERVED	single precision floating decimal	2	R
200EH	Freq	Frequency	single precision floating decimal	2	R
2010H	RESERVED	RESERVED	single precision floating decimal	2	R
Electrical data of the secondary side					
4000H	Ep	Active in electricity	single precision floating decimal	2	R

Change Protocol such as protocol switching, data for 2 for Modbus RTU protocol -, data to 1 for DL/T

645-2007;

The CLR. E power reset write 1 removal of total power;

BAud rate: 1:2400bps; 2:4800bps; 3:9600bps; ;

4. 4 Outline & Mounting Dimension

Outline dimension: 36mm×98mm×65mm;

DDSU666.004.0006 type single phase electronic energy meter(DIN-Rail)	ZTY0.464.1036
Operation manual	Page 12, Total 21

Din rail mounting dimension: 35mm, with configuration to be shown as figure 4:

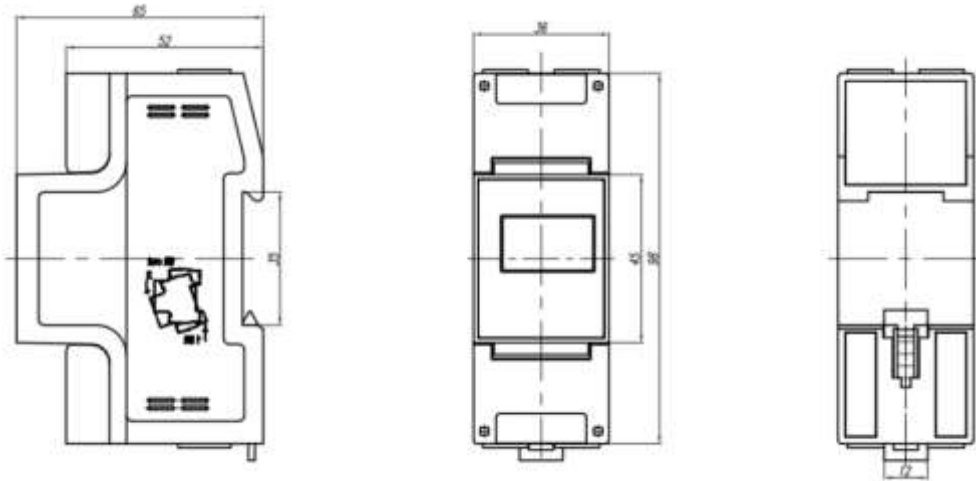

Figure 5 Configuration

6. Installation & Operation Instruction

6.1 Inspection

- 1) Before installation, firstly check whether the model No. and specification of the product on the package is the same as the object. If not, please contact the supplier.
- 2) Check whether the product shell in the carton is damaged, if is, please contact the supplier.

6.2 Installation

Directly clip the instrument on the rail and install it on the distribution box.

- 1) When installing, firstly clip one terminal of the slot and then clip to the rail with power.
- 2) When disassembling, press the movable card with a screwdriver and take out the instrument.

6.3 Wiring mode

6.3.1 Instruction of wiring terminal

Before powering, you must check whether the wiring mode of the instrument is correct, and the wiring diagram is shown as below:

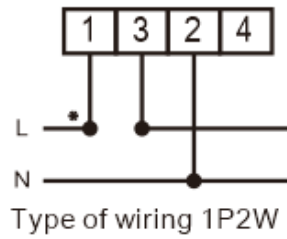

Figure 6 Direct connection

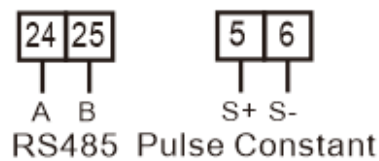
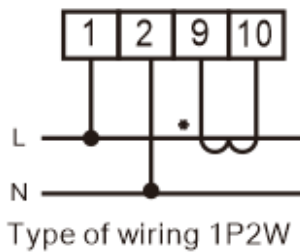

Figure 7 Via transformer

7. Diagnosis, analysis and elimination of common faults

Fault phenomenon	Analysis of causes	Troubleshooting	Remark
Display fault	The wiring may not be connected according to the wiring diagram of the meter	Check if the actual connection is the same as the requirement of the wiring diagram. Pay special attention to "N" position of the voltage, the high&low end of the current and terminal labeling are different from actual number.	While checking the connection, be sure the meter is in the state of disconnection, guarantee the

DDSU666.004.0006 type single phase electronic energy meter(DIN-Rail)	ZTY0.464.1036
Operation manual	Page 14, Total 21

			safety of human life.
Communication fault	The communication setting information of the meter may be incorrect	Check if the communication setting information such as communication address, baud rate, verification mode is the same as the PC settings.	

If the above method cannot eliminate the fault, please contact with the after-sale service of digital meter from Zhejiang CHINT Instrument Co., Ltd.

8. Transportation & Storage

The package of the instrument shall adopt materials complied with environmental protection, under package condition, the instrument and accessories shall be stored in the dry and ventilated places, to avoid humidity and corrosive gas erosion, with the limited environmental temperature for storage to be $-40^{\circ}\text{C} \sim +70^{\circ}\text{C}$ and relative humidity not exceeding 75%.

The package of the instrument shall comply with the provisions of GB/T 13384-2008 of General specifications for packings of mechanical and electrical products with the environmental temperature requirement and transportation for the normal storage complied with the provisions of GB/T 25480-2010 of Basic environmental conditions and testing methods for instruments transportation and storage

Complete set of package for single product, including:

- 1) One set of instrument
- 2) One operation manual
- 3) One bag of desiccant
- 4) Certificate

10. Maintenance & Service

We guarantee free reparation and change for the multi-meter if found any unconformity with the standard, under circumstance of that the users fully comply with this instructions and complete seal after delivery within 18 months.

DDSU666.004.0006 type single phase electronic energy meter(DIN-Rail)	ZTY0.464.1036
Operation manual	Page 15, Total 21

Appendix A: MODBUS-RTU Communication Protocol

A.1 Communication format

Information transmission adopts asynchronous mode, taking byte as the unit. The communication data transmitted between the host and slave computer is the format of 10-digit characters, including one start bit(0), 8 data bits without check bit, two stop bits(1)(other format can be customized).

Format of information frame:

Table A.1

Start	Address code	Function code	Data field	CRC check code	End
More than 3.5-character dead time	1 character	1 character	n characters	2 characters	More than 3.5-character dead time

DDSU666.004.0006 type single phase electronic energy meter(DIN-Rail)	ZTY0.464.1036
Operation manual	Page 16, Total 21

A.2 Communication information transmitting procedure

When communication command is transmitted from the host computer to the slave computer, the slave computer which matches the address code sent by the host computer receives the communication command. If CRC checks without any fault, then the corresponding operation will be carried out, after that the implement result (date) is returned to the host computer. The returned information contains address code, function code, implement date and CRC check code.

A.2.1 Address code

Address code is the first byte of each communication frame, with the range from 1 to 247. Each slave must have an exclusive address code in the bus, only the slave computer which matches the address code sent by the host computer can respond returned information. When the slave computer returns the information, the returned data will begin with their respective address codes. The address code sent from the host computer indicates the slave address, the returned address code from the slave computer indicates the slave address, while the corresponding address code indicates where the information comes from.

A.2.2 Function code

It's the second byte of each communication frame. It's sent by the host and tells the slave computer what actions should be carried out through function code. The slave will respond, and the functional code is the same as that sent by the host computer, which indicates that the slave computer has responded the host and complemented the relative operation.

The instrument supports the following two function codes:

Table A.2

Function code	Definition	Operation
03H	Read register	Read one or several register data
10H	Write multichannel register	Write n 16-bit binary data into n continuous registers

A.2.3 Data area

The data field will be different based on different function codes. These data can be numerical

DDSU666.004.0006 type single phase electronic energy meter(DIN-Rail)	ZTY0.464.1036
Operation manual	Page 17, Total 21

values, reference addresses and so on. For different slave computers, both the address and data information are different, and the communication information table should be provided.

The host utilizes communicate command (function code 03H and 10H) to read and modify the data registers of the slave freely. But the data length which is read or write at one time should not be out of the effective range of the data register's address.

A.3 Brief introduction of function code

A.3.1 Function code 03H: Read register

For example: The slave address which the host intends to read is 01H, the start register address is two register data of 0CH, sent by the host:

Table A.3

The host sends		Send message
Address code		01H
Function code		03H
Start register address	High byte	00H
	low byte	0CH
Register number	High byte	00H
	low byte	02H
CRC 校验码	low byte	04H
	High byte	08H

If the data of the slave register 0CH, 0DH is 0000H, 1388H, the slave will return:

Table A.4

The slave returns		Return message
Address code		01H
Function code		03H
Bytes		04H
Register 0CH data	High byte	00H
	low byte	00H
Register 0DH data	High byte	13H

DDSU666.004.0006 type single phase electronic energy meter(DIN-Rail)	ZTY0.464.1036
Operation manual	Page 18, Total 21

	low byte	88H
CRC check code	low byte	F7H
	High byte	65H

A.3.2 Function code 10H: Write multi-port register

For example: The host intends to save data of 0002H, 1388H, 000AH into the slave address of 01H, the start register address is the three registers of 00H, sent by the host:

Sent by the host:

Table A.5

The host sends		Send message
Address code		01H
Function code		10H
Start register address	High byte	00H
	low byte	00H
Register number	High byte	00H
	low byte	03H
Write bytes		06H
The data to be written in 00H register	High byte	00H
	low byte	02H
The data to be written in 01H register	High byte	13H
	low byte	88H
The data to be written in 02H register	High byte	00H
	low byte	0AH
CRC check code	low byte	9BH
	High byte	E9H

Returned by the slave

Table A.6

The slave returns	Return message
Address code	01H

DDSU666.004.0006 type single phase electronic energy meter(DIN-Rail)	ZTY0.464.1036
Operation manual	Page 19, Total 21

Function code		10H
Start register address	High byte	00H
	low byte	00H
Register number	High byte	00H
	low byte	03H
CRC check code	low byte	80H
	High byte	08H

A.4 16-digit CRC check code

The host or slave computer can be judged by the check code to see if the received information is correct or not. The interruption by electronic noises or other factors may cause errors during information transmission.

16-digit CRC check code is calculated by the host, located at the end of the transmit information frame. The slave recalculates the received information of CRC and compares if the calculated CRC goes in line with the received CRC, if not, there is an error. Only 8 data bits are used during CRC calculation, both the start bits and the stop bits are not involved in the calculation.

The calculation method of CRC check code is stated as follows:

- 1) Pre-arrange one 16-digit register as a hexadecimal FFFF (i.e. fully 1), the register is called CRC register;
- 2) Make the first 8-digit binary data (the first byte of the communication information frame) with the lower 8 digits of the 16-digit CRC register by XOR calculation, the result is placed in CRC register;
- 3) Shift the content of CRC register rightward by one digit (towards the lower digit) and fill in the highest digit with 0, check the shift-out digit after rightward shifting;
- 4) If the shift-out digit is 0: repeat step 3) (shift rightward one digit again);
If the shift-out digit is 1: make CRC register with multinomial A001 by XOR calculation
- 5) Repeat step 3) and 4) until shift rightward for 8 times, then all the 8 digits are processed;
- 6) Repeat step 2) and 5), process the next byte of the communication information frame;
- 7) After calculating all the bytes of the communication information frame (exclude CRC check

DDSU666.004.0006 type single phase electronic energy meter(DIN-Rail)	ZTY0.464.1036
Operation manual	Page 20, Total 21

code) according to the above steps, the content of the CRC register to be get is: 16-digit CRC check code.

A.5 Error handling

When the meter detects other errors except the error of CRC check code, the information will be returned to the host, the highest digit of the function code is 1, i.e. the function code returned to the host from the slave is adding 128 base on the function code sent from the host. The error returned from the slave is as follows:

Table A.7

Address code	Function code (top digit is 1)	Error code	CRC check code low byte	CRC check code High byte
1 byte	1 byte	1 byte	1 byte	1 byte

Error code is as follows:

Table A.8

01H	Illegal function code	The function code received is not supported by the instrument
02H	Illegal register address	The register address received is out of the register address range
03H	Illegal data value	The data value received is out of the corresponding address data range

DDSU666.004.0006 type single phase electronic energy meter(DIN-Rail)	ZTY0.464.1036
Operation manual	Page 21, Total 21

Dear clients,

Please assist us: when the product life is end, to protect our environment, please recycle the product or components, while for the materials that cannot be recycled, please also deal with it in a proper way. Really appreciate your cooperation and support.

Name of Company: Zhejiang Chint Instrument & Meter Co., Ltd.

Address: Wenzhou Bridge Industrial Zone, Yueqing, Zhejiang, China.

Zip Code: 325603

Telephone: 0577-62877777

Fax: 0577-62891577

Technical hotline: 0577-62919999

Fake Complaint: 0577-62789987

Website: <http://www.chint.com>

Email: ztyb@chint.com

Date of Issue: May, 2019.

No.: ZTY0.464.1224V1